

TUMBLE DRYER



English

Contents

GB

Installation, 2

Warnings, 4

Care and Maintenance, 6

Description of the tumble dryer, 7

Control panel, 7

Start and Programmes, 8

Laundry, 11

Troubleshooting, 11

Service, 12

www.hotpoint.eu



This symbol reminds you to read this instruction manual.

! Keep this manual at hand for immediate reference whenever necessary. Always store this manual close to the tumble dryer and remember to pass it on to any new owners when selling or transferring the appliance, so they may familiarise with the warnings and suggestions herein contained.

! Read these instructions carefully: the following pages contain important information on installation and useful suggestions for operating the appliance.

Installation

GB Where to install the tumble dryer

If the dryer is installed below a worktop, ensure there are 10 mm between the upper panel of the dryer and any objects above it, and 15 mm between the sides of the machine and the walls or furniture units adjacent to it. This ensures adequate air circulation. Make sure the air inlets on the rear panel are not blocked or obstructed.

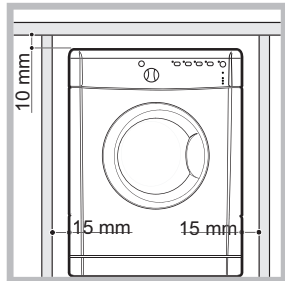

Ventilation

This appliance gently dries laundry by taking in cold, clean and relatively dry air, heating it and passing it through the fabric. To facilitate the drying process, damp air is expelled at the rear, through a ventilation hose. When the dryer is in use, there has to be adequate ventilation to avoid a back flow of gases into the room from appliances burning other fuels, including open fires.

Mobile ventilation system

When using the tumble dryer with the mobile ventilation system, a ventilation hose must be connected. The hose should be securely fastened to the ventilation hole at the rear of the appliance (see "Description of the tumble dryer"). We recommend the hose is connected to an outlet near the tumble dryer, if possible. If it cannot be installed in a permanent spot, the tumble dryer will still function perfectly well if the ventilation hose is passed through a partially-opened window.

Make sure you do not point the ventilation hose towards the air inlet, which is located on the rear of the appliance.

The ventilation hose should not exceed a maximum length of 2.4 metres; it should also be shaken frequently to remove any fluff, dust or water deposits inside it. Make sure you do not crush the hose. **The hose supplied has an oval section to aid installation.**

Fixed ventilation kit

We recommend the ventilation hose is connected to a ventilation kit for windows or doors, available from the retailer which originally sold you the appliance or from your local spare parts stockist.

Wall ventilation hole

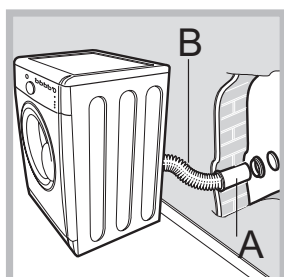

1. Leave an opening in the wall.
2. Make the hose as short and straight as possible, in order to prevent any moisture from condensing and leaking back into the appliance.
3. The hole in the wall must also be straight and pointing downwards, so that the flow of air coming out is not impeded.

Areas **A** and **B** should be checked frequently, to prevent the accumulation of fluff or debris, particularly if the tumble dryer is used very often. The hose adaptor must be fitted correctly, in order to prevent damp air from coming back into the room.

GUIDE TO FITTING THE VENT HOSE TO YOUR DRYER

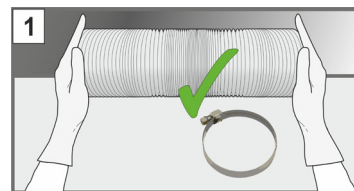

please wear gloves when cutting the hose.

Remove oval-shaped Ventilation hose from the packaging. Ensure that you also remove the two jubilee clips. If you require to reduce the length of the hose

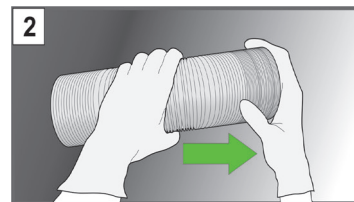

Pull to expand the end of the Ventilation hose prior to fitting. If the hose has not been expanded, the jubilee clip will not clamp the hose to the adaptor.

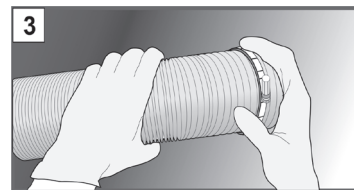

a wall mounting kit (not supplied).

Place one of the the jubilee clips over the end of the extended vent hose. The second jubilee clip can be used to secure the opposite end of the vent hose to

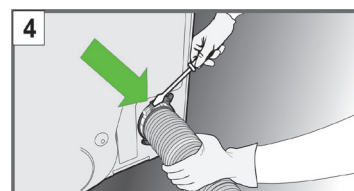

the hose to the rear vent outlet.

The tumble dryer may protrude further forward from the worktop. Please do not push the tumble dryer too far backward.

Clamp the ventilation hose to the rear vent outlet by tightening the jubilee clip with a screwdriver. If the hose has not been expanded, the clip will not clamp

Ventilation hole

The ventilation hole should be directly behind the dryer in order to keep the hose as short as possible.

Make sure you do not push the tumble dryer too far backwards, as this could lead to the ventilation hose being crushed, bent or even disconnected.

There should be no cuts, kinks or "U"-shaped bends in the hose, as these could impede ventilation or trap condensation.

The end of the hose must be facing downwards, in order to prevent the hot, damp air from forming condensation in the room or the tumble dryer.

Make sure that the tumble dryer is adequately ventilated, and that the end of the ventilation hose is not pointing towards the air inlet pipe on the rear of the appliance. The ventilation hose must always be fitted to ensure

optimum performance. The hose will need to be expanded to be fitted and clamped.

Make sure that the ventilation hose, air inlet vents, and outlets are not obstructed or blocked.

Do not let the tumble dryer recirculate exhaust air.

Improper use of the tumble dryer may result in fire hazards.

Ventilation

The air emitted by the tumble dryer must not be expelled in the same duct as used for the fumes produced by different appliances which burn gas or other fuels.

Do not discharge the exhaust air into an extraction system or any duct with an extractor fan. This will affect the way the thermal controls operate and can result in a fire hazard.

- ⚠ Make sure that the room in which the tumble dryer is installed is not damp, and that it is adequately ventilated.
- ⚠ We do not recommend that the dryer is installed in a cupboard but the dryer must never be installed behind a lockable door, a sliding door or a door with a hinge on the opposite side to that of the dryer door.
- ⚠ The appliance must be installed with the rear surface placed against a wall.

Electrical connections

Before plugging the appliance into the socket, check the following:

- ⚠ Make sure your hands are dry.
- ⚠ The socket must have an earth connection.
- ⚠ The socket must be able to withstand the machine's maximum power output as indicated on the rating plate (see *Description of the tumble dryer*).
- ⚠ The power supply voltage must fall within the values indicated on the rating plate (see *Description of the tumble dryer*).
- ⚠ Do not use extension leads. Do not pull the power supply cable. Do not use multiple plug adaptors if the appliance is fitted with a plug. For appliances with fitted plug, if the plug is not suitable for your socket outlet, contact a qualified technician.

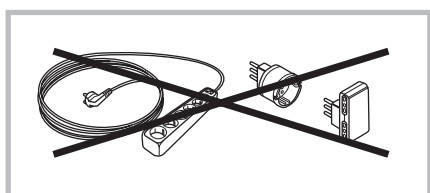

- ⚠ The dryer must not be installed outdoors, even if the space is sheltered.
- ⚠ Once installed, the dryer's electrical wire and plug must be within reach.
- ⚠ The power cord must not be bent or squashed.
- ⚠ If the plug being replaced is a non-rewirable type, then the cut-off plug must be disposed of safely. DO NOT leave it where it can be inserted into a socket and create a shock hazard.
- ⚠ The electric cord must be regularly checked. If the supply cord is damaged, it must be replaced by service agent. (see *Service*).
- ⚠ The manufacturer denies any responsibility should any of these rules not be followed.
- ⚠ **If in doubt about any of the above consult a qualified electrician.**

Levelling the tumble dryer

The tumble dryer should be installed level in order to operate correctly.

After installing the tumble dryer in its permanent position, make sure it is level; check its side-to-side levelling first, followed by front-to-back.

If the tumble dryer is not perfectly level, use a wooden block to support it while you adjust the two front feet, up or down as necessary.

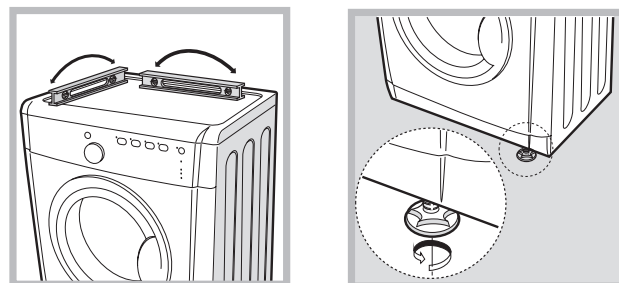

Before you start your dryer

Once the tumble dryer is installed, clean the inside of the drum before operating it and remove any dirt accumulated during transportation.

Warnings

GB

! This appliance has been designed and built according to international safety standards. These warnings are given for safety reasons and must be followed carefully.

General safety

- This appliance can be used by children aged from 8 years and above and persons with reduced physical, sensory or mental capabilities or lack of experience and knowledge if they have been given supervision or instruction concerning use of the appliance in a safe way and understand the hazards involved.
- This tumble dryer has been designed for home, and not professional, use.
- Do not touch the appliance while barefoot or with wet hands or feet.
- Unplug the machine by pulling on the plug, not the cord.
- Children should be supervised to ensure that they do not play with the dryer.
- Cleaning and user maintenance shall not be made by children without supervision.
- Children of less than 3 years should be kept away from the appliance unless continuously supervised.
- The appliance must be installed correctly and have proper ventilation. The air intake vents behind the machine, the outlet vents and the vent tube should never be obstructed (see Installation).
- Never direct the vent tube outlet towards the air intake at the back of the machine.
- Never allow the tumble dryer to recycle exhaust air.
- Never use the dryer on carpeting where the pile height would prevent air from entering the dryer from the base.
- Check to see if the dryer is empty before loading it.
-  The back of the dryer could become very hot. Never touch it while in use.
- Do not use the dryer unless the filter, is securely in place (see Maintenance).
- Do not overload the dryer (see Laundry for maximum loads).
- Do not load items that are dripping wet.
- Carefully check all instructions on clothing labels (see Laundry).
- Do not tumble dry large, very bulky items.
- Do not tumble dry acrylic fibres at high temperatures.
- Do not turn off the dryer when there are still

warm items inside.

- Clean the filter after each use (see Maintenance).
- Do not allow lint to collect around the dryer.
- Never climb on top of the dryer. It could result in damage.
- Always follow electrical standards and requirements (see Installation).
- Always buy original spare parts and accessories (see Service).

To minimise the risk of fire in your tumble dryer, the following should be observed:

- Tumble dry items only if they have been washed with detergent and water, rinsed and been through the spin cycle. It is a fire hazard to dry items that HAVE NOT been washed with water.
- Do not dry garments that have been treated with chemical products.
- Do not tumble dry items that have been spotted or soaked with vegetable or cooking oils, this constitutes a fire hazard. Oil-affected items can ignite spontaneously, especially when exposed to heat sources such as a tumble dryer. The items become warm, causing an oxidation reaction with the oil, Oxidisation creates heat. If the heat cannot escape, items can become hot enough to catch fire. Piling, stacking or storing oil-affected items can prevent heat from escaping and so create a fire hazard. If it is unavoidable that fabrics containing vegetable or cooking oil or those that have been contaminated with hair care products be placed in a tumble dryer they should first be washed with extra detergent - this will reduce, but not eliminate the hazard. They should not be removed from the dryer and piled or stacked while hot.
- Do not tumble dry items that have previously been cleaned in or washed in, soaked in or soiled with petrol/gasoline, dry cleaning solvents or other flammable or explosive substances. Highly flammable substances commonly used in domestic environments including cooking oil, acetone, denatured alcohol, kerosene, spot removers, turpentine, waxes and wax removers. Ensure these items have been washed in hot water with an extra amount of detergent before being dried in the tumble dryer.



- Do not tumble dry items containing foam rubber (also known as latex foam), or similarly textured rubber like materials. Foam rubber materials can, when heated, produce fire by spontaneous combustion.
- Fabric softener or similar products should not be used in a tumble dryer to eliminate the effects of static electricity unless the practice is specifically recommended by the manufacturer of the fabric softener product.
- Do not tumble dry undergarments that contain metal reinforcements eg. bras with metal reinforcing wires. Damage to the tumble dryer can result if the metal reinforcements come loose during drying.
- Do not tumble dry rubber, plastic articles such as shower caps or babies waterproof covers, polythene or paper.
- Do not tumble dry rubber backed articles, clothes fitted with foam rubber pads, pillows, galoshes and rubber coated tennis shoes.
- Remove all objects from pockets such as lighters and matches.

WARNING: Never stop the dryer before the end of the drying cycle unless all items are quickly removed and spread out so that the heat is dissipated.

Save energy and respect the environment

- Wring out all items to eliminate excess water before tumble drying (if you use a washing machine first, select a high spin cycle). Doing this will save time and energy during drying.
- Always dry full loads - you save energy: single items or small loads take longer to dry.
- Clean the filter after each use to contain energy consumption costs (see Maintenance).

Maximum load sizes: 8 kg

Power consumption			
off-mode (Po) - Watts			0.14
left-on mode (PI) - Watts			0.14
Programs	Kg	kWh	Minutes
Standard cotton* 	8	4.99	129
Standard cotton 	4	2.66	67
Synthetics	4	1.51	50
* This is the reference program for the energy label and suitable to dry normal wet cotton laundry. This is the most efficient programme in terms of energy consumption for drying wet cotton laundry.			



WARNING



Fire Hazard

Use a Flexible metal vent tube.
 Do not use a plastic vent tube.
 Do not block or obstruct the tube in installation.
 Failure to follow these instructions can result in death or fire.

Care and maintenance

GB

Disconnecting the power supply

! Disconnect the dryer when not in use or during cleaning and maintenance operations.

Cleaning the filter after each cycle

The filter is a fundamental component of the dryer: its function is to collect lint and fluff that form during drying.



Clean the filter once drying is completed, by rinsing it under running water or cleaning it with a vacuum cleaner. Should the filter become clogged, the flow of air inside the dryer will be seriously hampered:

drying times becomes longer and more energy is consumed. Moreover, the dryer may become damaged.

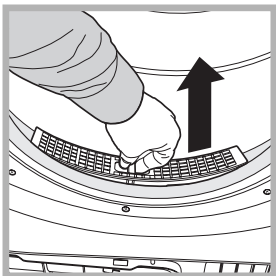

The filter is located behind of the dryer seal (see *Picture*).

Removing the filter:

1. Pull the filter's plastic handle upwards (see *Picture*).

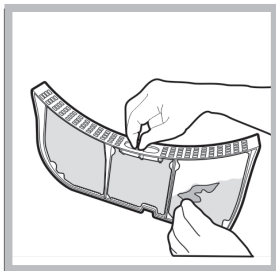

2. Clean the fluff off the filter and replace it correctly. Ensure that the filter is pushed fully home.

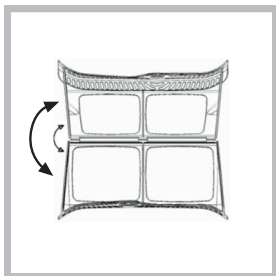

! Do not use the dryer unless the filter has been replaced in its holder.

Checking the drum after each cycle

Rotate the drum manually to remove smaller items (handkerchiefs) that could have been left inside the dryer.

Cleaning the drum

! Avoid using abrasives, steel wool or stainless steel cleaning agents to clean the drum.

A coloured film may appear on the stainless steel drum surface: it may be caused by a combination of water and/or cleaning agents such as fabric conditioners. This coloured film does not affect the dryer's performance.

Cleaning the tumble dryer

- The external metal and plastic parts and the rubber parts can be cleaned with the aid of a damp cloth.
- Periodically check the vent hose and all other parts of the venting system and remove any accumulations of fluff and lint.

! Do not use solvents or abrasives.

! Have the dryer checked regularly by authorised technical personnel in order to ensure that the electrical and mechanical parts work safely (see *Assistance*).

Description of the tumble dryer

Hotpoint

GB

Front side

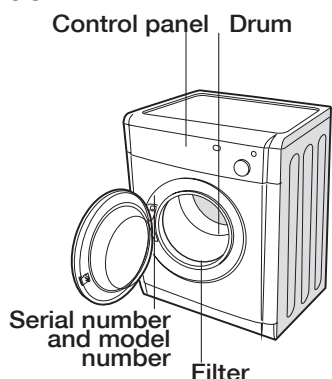

Rear side

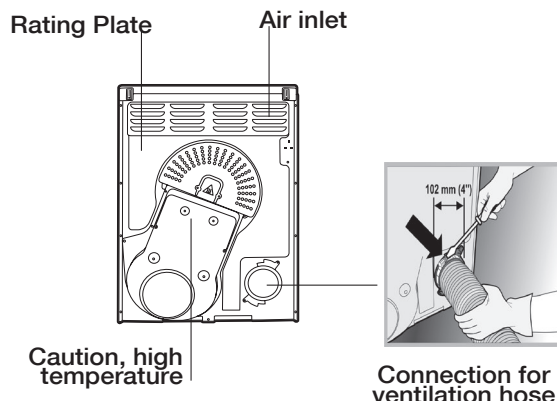

Control panel

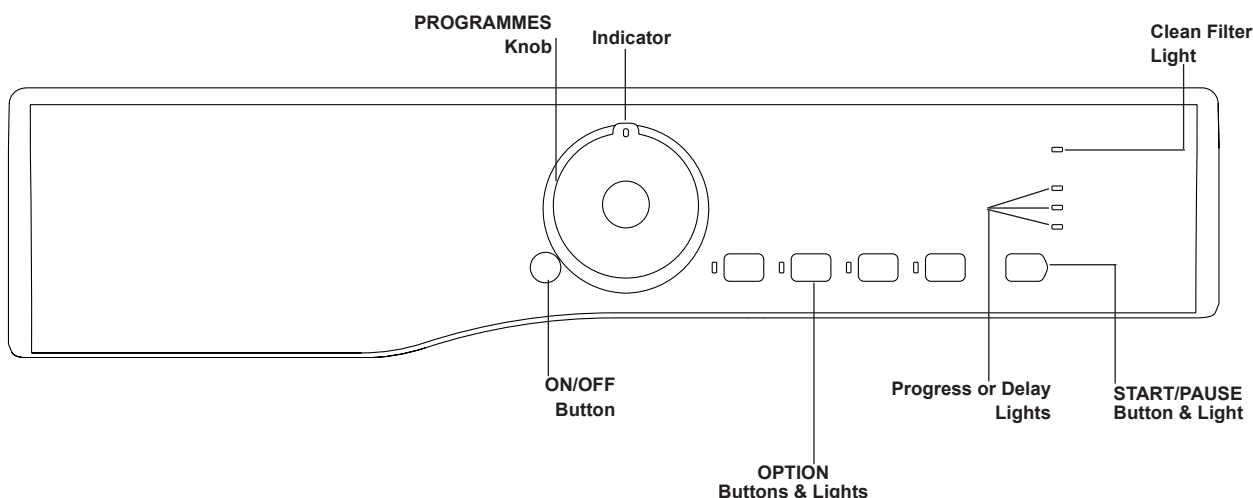

The ON/OFF button : If the dryer is running and this button is pressed and held for more than 3 seconds the dryer is turned off, the programme is then cancelled. Press and hold for more than 3 seconds and the dryer reactivates.

The **PROGRAMMES** knob sets the programme: rotate it until the indicator is pointing to the programme you want to select or to Timed Drying (see *Start and Programmes*).

The **OPTION** buttons/lights select available options for your selected programme. The lights indicate that the option has been selected (see *Start and Programmes*).

The **START/PAUSE** button/light  starts a selected programme. When you press this button there will be one beep and the progress lights will flash to confirm the action. When a programme is running, pressing this button in pauses the programme and stops the dryer. The light is green when programme is running, flashing amber

if the programme has been paused or flashing green if on standby waiting to start a programme (see *Start and Programmes*).

Note: This light also flashes amber during the Post Care phase of a programme.



The **Progress or Delay** lights show you the status of the programme, or the delay time when they flash. During a delayed start the lights flash to show the delay selected. When (not flashing) they show each stage of the programme by the corresponding light turning on (see *Start and Programmes*).

The **Clean Filter** light gives you a reminder before every programme that it is essential to clean the filter every time the dryer is used (see *Maintenance and Care*).

Start and Programmes

GB

Choosing a programme

1. Plug the dryer into the electrical socket.
2. Sort your laundry according to fabric type (*see Laundry*).
3. Open the door and make sure the filter is clean and in place (*see Maintenance*).
4. Load the machine and make sure items are not in the way of the door seal. Close the door.
5. If none of the lights are on: Press the ON/OFF button .
6. Choose a programme, or Timed Drying, by checking the Programmes Guide (*see Programmes*) as well as the indications for each type of fabric (*see Laundry*).
 - Select a programme by rotating the PROGRAMMES knob.
7. Choose Timed Drying or Dryness Levels option.
8. Set a delay time and other options if necessary.
9. The START/PAUSE light is flashing green:
 - press the START/PAUSE  button to begin. The green light stops flashing.

During the drying programme, you can check on your laundry and take out items that are dry while others continue drying. When you close the door again, press the

START/PAUSE button in order to resume drying.
(When the door is opened the START/PAUSE light will flash Amber, after the door is closed and the START/PAUSE button pressed, the START/PAUSE light will stop flashing and show green.)

Note: During the Post Care phase this light flashes Amber.

10. At the end of the drying cycle the End light comes on and either :

- The buzzer will beep 3 times to let you know that your programme is complete.

- or- If you have selected the Crease Care option and you do not take the items out immediately, the items will tumble occasionally for 10 hours or until you open the door, the buzzer will then beep 3 times to confirm the programme is completed.

11. Open the door, take the laundry out, clean the filter and replace it.

12. Unplug the dryer.

Note: This tumble dryer, in compliance with new energy saving regulations, is fitted with an automatic standby system which is enabled after about 30 minutes if no activity is detected. Press and hold the ON/OFF button until the dryer reactivates.

n°	Programme	Description of program	Cycle duration*
	Max. load	Notes/ Options available	
1	Ready to Wear	<ul style="list-style-type: none"> This is a programme for cotton items. Dries your items ready for using, drier than programme Standard Cotton. 	140'
	max	Delay Timer - Crease Care	
2	Standard Cotton	<ul style="list-style-type: none"> This is a programme for cotton items. Clothes dried using this programme are usually ready to put away. The Standard Cotton programme to EU Regulation 392/2012 is Programme 1 selection with High Heat and Dryness Level Cupboard Dry (the standard/default configuration). This is the most efficient programme in terms of energy consumption (EU 392/2012). 	130'
	max	Fibre Care - Delay Timer - Crease Care	
3	Easy Iron	<ul style="list-style-type: none"> This is a programme for cotton items. Dries your items to a dryness level that allows them to minimise ironing. 	125'
	max	Fibre Care - Delay Timer - Crease Care	
4	Synthetics	<ul style="list-style-type: none"> Recommended to delicately dry synthetic fabrics. Clothes dried using this programme are usually ready for putting away. 	60'
	4 kg	Delay Timer - Crease Care	
5	Synthetics Easy Iron	<ul style="list-style-type: none"> This is a programme for items of Synthetic or Synthetic/Cotton mixtures, with a level of dryness that minimizes ironing. 	40'
	4 kg	Delay Timer - Crease Care	
6	Silk	<ul style="list-style-type: none"> This is a programme for drying your delicate silk. Loads dried using this programme are usually ready to use, but on some heavier garments the edges may be slightly damp. If this is the case, remove the load and open them out and then run the programme again for a short period. 	30'
	0.5 kg	-	

n°	Programme	Description of program	Cycle duration*
	Max. load	Notes/ Options available	
7	Wool	<ul style="list-style-type: none"> This is a programme for tumble dryer safe garments marked with the symbol . We recommend that garments are turned inside out before drying. Loads dried using this programme are usually ready to wear, but on some heavier garments the edges may be slightly damp. Allow these to dry naturally as over-drying could damage garments. <p>! Unlike other materials, the mechanism of wool shrinkage is irreversible; i.e. it will not stretch back to original size and shape. ! This programme is not suitable for Acrylic garments.</p>	60'
	1 kg	-	
8	Bed & Bath	<ul style="list-style-type: none"> This is a programme for cotton towels and sheets. Loads dried using this programme are usually ready to use, the edges or seams may be slightly damp especially on large items. If this is the case, try opening them out and running the programme again for a short period. 	140'
	Max	Delay Timer - Crease Care	
9	Shirts	<ul style="list-style-type: none"> This is a programme for shirts made from synthetic materials or a mixture of natural and synthetic materials, such as polyester and cotton. It can be used for load sizes up to 3kg (approximately 14 shirts). Loads dried using this program are usually ready to wear, the edges or seams may be slightly damp. If this is the case, try turning the shirts inside out and running the programme again for a short period. 	80'
	3 kg	Fibre Care - Delay Timer - Crease Care	
10	Jeans	<ul style="list-style-type: none"> This is a programme for jeans made from denim cotton. Before drying your jeans turn the front pockets inside out. Do not mix dark and light coloured items. It can also be used on other garments made from the same material, such as jackets. Loads dried using this programme are usually ready to wear, the edges or seams may be slightly damp. If this is the case, try turning the jeans inside out and running the programme again for a short period. <p>! We do not recommend that you use this programme if your jeans have elastic waist bands, studs or embroider</p>	75'
	3 kg	Delay Timer - Crease Care	
11	Baby Cycle	<ul style="list-style-type: none"> This is a programme for drying your baby's small delicate items of clothing and bedding (Cotton and Chenille) and for drying your delicate clothes. DO NOT dry items such as bibs and nappy pants with plastic coverings. Loads dried using this programme are usually ready to wear, but on some heavier garments the edges may be slightly damp. If this is the case, try turning items inside out and running the programme again for a short period. 	50'
	2 kg	Delay Timer - Crease Care	
12 13 14 15	Timed Drying	<p>Timed drying cycle (15' - 40' - 60' - 90')</p> <ul style="list-style-type: none"> This programme can be used instead of the automatic programmes when you desire setting a time for the drying cycle. It is ideal for drying damp laundry with the low heat setting or for small loads. <p>The duration of the timed drying cycle to be selected depends on the size of the load, on the fabric to be dried (see Table) and the spin speed used in your washer.</p> <p>The COOL TUMBLE cycle runs during the final minutes of the programme (see Advice for timed dry programmes)</p>	-
	-	Fibre Care - Delay Timer - Crease Care	
16	Refresh	<p>! 'Refresh' is not a drying programme and should not be used for wet articles of clothing.</p> <ul style="list-style-type: none"> It can be used on any load size, but is more effective on smaller loads. Do not overload your dryer (see Laundry). This is a 20 minute programme that airs your clothes with cool air. Also use to cool warm clothes. 	20'
	-		

***Note:**

The duration of the program will depend on the size of the load, types of textiles, the spin speed used in your washer and any extra options selected.

The Controls

- **PROGRAMMES knob**

! Warning, if after pressing the start button, the programmes knob position is changed, the new position will **NOT** change the programme selected. To change a selected programme, press the Start/Pause button >||, the light flashes Amber to indicate the programme is paused. Select the new programme and any options required, the light will then flash green. Press the Start/Pause button >|| again and the new programme will start.

- **OPTION buttons / lights**

These buttons are used to customise the selected programme to your requirements. Not all options are available for all programmes. Some options are incompatible with the ones previously set. If an option is not available and you press the button, the buzzer will beep three times. If the option is available the option light next to the button lights to confirm the selection.

Progress (☀️ Drying, 🌀 Cool Tumble, End) / Delay (3hr 6hr 9hr) Lights

When the light next to the delay button is on, these lights flash to indicate the delay time selected. During other programmes they indicate the progress of the dryer, each one comes on as the corresponding phase starts.

Delay Timer

The start of some programmes (see *Start and Programmes*) can be delayed for up to 9 hours in 3hr steps.

When a delayed start is in progress the light next to the delay button will be on and the selected delay period light will flash (after the start button has been pressed). To set a delayed start, press the Delay Timer button, and the light next to the button will come on together with the 3hr delay light. Pressing the button again will advance the delay setting to 6hr, the 3hr light goes out and the 6hr light is on. Each time you press the button the delay setting advances 3 hours, as indicated by the corresponding light. If the 9hr light is on, pressing the button again will cancel the delay. Holding in the On/Off button will also cancel.

Crease Care

The *pre-care option* is only available if a delayed start has been selected. It tumbles the clothes occasionally during the delayed period to help prevent creases developing. The *post-care option* occasionally tumbles the clothes after the end of the drying and cool tumble cycles to prevent creases

developing, should you not be available to remove the load immediately the programme is complete. The End light is on during this phase. **Note:** The Start/Pause light flashes Amber during this phase. Selecting this option enables both the pre and post care functions if appropriate.

Fibre care

Fibre Care is a special option designed to gently dry delicate clothes.

Press this button to select the low temperature setting; the light next to the button will switch on. Activating this option will increase the duration of the cycles

Key Lock

Keep this button pressed for a few seconds after choosing the programme and the desired options. When the warning light is on, the other buttons and the knob are deactivated. To deactivate the block keep the button pressed and the warning light goes off. The ON/OFF button switches off the machine even if the function lock button is active.

Key Lock can be selected with all programs.

- **Door Opening**

Opening the door (or pressing the Start/Pause button) during a programme will stop the dryer and have the following effects: **Note:** The Start/Pause light flashes Amber during the Post Care phase of a programme.

- The Start/Pause light flashes Amber.
- During a delay phase the delay will continue to count down. The Start/Pause button **must** be pressed to resume the delay programme. One of the delay lights will flash to show the current delay setting.
- The Start/Pause button **must** be pressed to resume the programme. The progress lights will change to show the current status and the Start/Pause light will stop flashing and turn green.
- During the Post Care phase of a drying programme, the programme will finish. Pressing the Start/Pause button will re-start a new programme at the beginning.
- Changing the programmes knob will select a new programme and the Start/Pause light will flash green. You can use this to select the 🌀 Refresh programme to cool the clothes, if you find them dry enough. Press the Start/Pause button to begin a new programme.

- **Note**

If you have a power cut, switch off the power or remove the plug. When power is restored, press and hold the ON/OFF button until the dryer reactivates, then press the Start/Pause button.

Advice for timed dry programmes

Fabric	Load				
	1 kg	2 kg	3 kg	4 - 5 kg	6 - 7 kg
Cotton – high heat	30 minutes	30 or 60 minutes	60 minutes	60 or 90 minutes	90 minutes
Synthetics – high heat	30 minutes	30 or 60 minutes	60 or 90 minutes	60 or 90 minutes	-
Acrylics- low heat	30 minutes	60 minutes			

Sorting laundry

- Check the symbols on the care labels of the various garments to verify whether the garments can be safely tumble dried.
- Sort laundry according to the type of fabric.
- Empty all pockets and check for loose buttons.
- Close zips and hooks and fasten belts and strings without tightening them.
- Wring out garments to remove the maximum amount of water possible.

! Do not load the dryer when garments are dripping wet.

Maximum load sizes

Do not overload the drum.

The following values indicate the weight of dry garments:





Natural fibres: maximum 8 kg

Synthetic fibres: maximum 4 kg

! Do not overload the dryer as this may result in reduced drying performance.

Care labels

Always check the care labels, especially when placing garments in the tumble dryer for the first time. Below are the most commonly used symbols:

-  May be tumble dried.
-  Do not tumble dry.
-  Tumble dry – high heat.
-  Tumble dry – low heat.

Drying times

Drying times are approximate and may vary depending on the following:

- Amount of water retained by items after the spin cycle: towels and delicate items retain a lot of water.
- Fabrics: items of the same fabric, but with different texture and thickness may have different drying times.
- Amount of laundry: single items and small loads may take longer to dry.
- Drying: if items are to be ironed, they can be removed from the dryer while still slightly damp. Items that require complete drying can be left longer.
- Heat setting.
- Temperature of the room: the lower the temperature of the room, the longer it will take for the dryer to dry clothing.
- Bulk: certain bulky items require special care during the drying process. We suggest removing these items and replacing them in the dryer once they have been shaken out: repeat this procedure several times during the course of the drying cycle.

! Do not over-dry items.

All fabrics contain natural dampness which helps to keep them soft and fluffy.

Troubleshooting

One day your dryer seems not to be working. Before you call your Service Centre (**see Service**), go through the following troubleshooting suggestions:

Problem:

The tumble dryer won't start.

Possible causes / Solution:

- The plug is not plugged into the socket, or not making contact.
- There has been a power failure.
- The fuse has blown. Try to plug another appliance into the socket.
- You are using an extension cord? Try to plug the dryer's power cord directly into the socket.
- The door is not closed securely?
- The PROGRAMMES knob has not been set properly (**see Start and Programmes**).
- The Start/Pause button has not been pressed (**see Start and Programmes**).
- On machines equipped with "Locked" function, check the option is not enabled (**see Programmes and options**).

Drying cycle will not begin.

Its taking a long time to dry.

- You have set a delayed time (**see Start and Programmes**).
- The filter has not been cleaned (**see Care and Maintenance**).
- The correct programme has not been selected for the type of fabric you are drying (**see Start and Programmes**)
- The flexible vent tube is obstructed (**see Installation**)
- The air intake grille is obstructed (**see Installation**).
- The permanent ventilation flap on the storm cover is obstructed (**see Installation**).
- The items were too wet (**see Laundry**).
- The dryer was overloaded (**see Laundry**).

Programme finishes and clothes are damper than expected..

! For safety the dryer has a maximum programme time of 5 hours. If an automatic programme has not sensed the required final moisture in this time the dryer will complete the programme and stop. Check the above points and run the programme again, if the results are still damp, contact the Service Centre (**see Service**).

The START/PAUSE light flashes amber and all Option lights also flash to indicate a fault.

- Try turning the dryer off and remove the plug. Then replace the plug and turn on, if a fault is still shown when you turn the dryer back on: note the lights that are on (not flashing) and contact the Service Centre (**see Service**).



Before contacting the Technical Assistance Centre:

- Follow the troubleshooting guide to check whether problems can be solved personally (see *Troubleshooting*).
- If not, switch the dryer off and contact the Technical Assistance Centre closest to you.

Spare parts

This dryer is a complex machine. Attempting to repair it personally or with the aid of an unqualified personnel may put the safety of people at risk, damage the machine or invalidate the spare parts guarantee.

Always contact a qualified technician when experiencing problems with this machine.

Product Guarantee And Repair Information

Guarantee

12 Months Parts and Labour Guarantee

Your appliance has the benefit of our manufacturer's guarantee, which covers the cost of breakdown repairs for twelve months from the date of purchase.

This gives you the reassurance that if, within that time, your appliance is proven to be defective because of either workmanship or materials, we will, at our discretion, either repair or replace the appliance at no cost to you:

This guarantee is subject to the following conditions:

- The appliance has been installed and operated correctly and in accordance with our operating and maintenance instructions.
- The appliance is used only on the electricity or gas supply printed on the rating plate.
- The appliance has been used for normal domestic purposes only.
- The appliance has not been altered, serviced, maintained, dismantled, or otherwise interfered with by any person not authorised by us.
- Any repair work must be undertaken by us or our appointed agent.
- Any parts removed during repair work or any appliance that is replaced become our property.
- The appliance is used in the United Kingdom or Republic of Ireland.

The guarantee does not cover:

- Damage resulting from transportation, improper use, neglect or interference or as a result of improper installation.
- Replacement of any consumable item or accessory. These include but are not limited to: plugs, cables, batteries, light bulbs, fluorescent tubes and starters, covers and filters.
- Replacement of any removable parts made of glass or plastic.

THIS GUARANTEE WILL NOT APPLY IF THE APPLIANCE HAS BEEN USED IN COMMERCIAL OR NON-DOMESTIC PREMISES.

Repairs and After Sales

For product help and advice, repairs, spare parts or accessories, we're here to help.

For local repair engineers - **03448 111 606** ROI - **0818 313 413** UK standard local rate applies ROI local Irish rate applies

For Parts and Accessories visit: parts.hotpoint.co.uk/shop

Please remember to register your appliance at www.hotpointservice.co.uk to activate your 10 year parts guarantee.

Please note, our advisors will require the following information: model number, serial number

This information can be found on the data plate located behind the door.

Information on recycling and disposal

As part of our continual commitment towards environmental protection, we reserve the right to use recycled quality components to reduce costs for our customers and to minimise materials wastage.

- Disposing of the packaging materials: follow local regulations to allow for recycling of packaging materials.
- In order to minimise the risk of injury to children, remove the door and plug, then cut the power supply cord flush with the appliance. Dispose of these parts separately to prevent the appliance from being connected to a power supply socket.

Disposal of old household appliances



European Directive 2012/19/EC concerning Waste Electrical and Electronic Equipment (WEEE) states that household appliances should not be disposed of using the normal solid urban waste cycle. Exhausted appliances should be collected separately in order to optimise the cost of re-using and recycling materials comprising the machine, while preventing potential damage to public health and the environment. The crossed-out wheeled bin symbol appears on all

products to remind owners of the obligations regarding separate waste collection.

Owners should contact their local authorities or appliance dealers for further information concerning the correct disposal of household appliances.



This appliance has been designed, constructed and distributed in compliance with the requirements of European Directives:

- LVD 2014/35/EU, EMC 2014/30/EU and RoHS 2011/65/EU.